



IMPORTANT



**Be Sure
to Read this
Manual
Before Use**



www.unistechnology.com

Operation Manual

WE ARE HERE TO ASSIST For parts and service



Have Questions? Contact us!

UNIS SERVICE CENTER

Tel: 972-241-4263

Email: service@unispartsandservice.com

www.unispartsandservice.com

When contacting Service, you will need the following information
and the name of your authorized distributor.

INDOOR MACHINE	
NAME: Octonauts-Peso GMP	MAX POWER: 300W
MODEL: B-420	MIN POWER: 250W
S/N:	FREQUENCY: 50/60HZ
VOLTAGE: AC110V~	DATE:
Guangdong UNIS Technology Co.,Ltd	

INDOOR MACHINE	
NAME: Octonauts-Peso GMP	MAX POWER: 450W
MODEL: B-420	MIN POWER: 280W
S/N:	FREQUENCY: 50/60HZ
VOLTAGE: AC220V~	DATE:
Guangdong UNIS Technology Co.,Ltd.	



CONTENT

IMPORTANT SAFETY INSTRUCTIONS.....	3
1. SPECIFICATIONS.....	5
2. CONTENTS OF THE ACCESSORY KIT.....	6
3. PART NAME.....	7
4. SET UP & INSTALLATION.....	8
5. HOW TO PLAY.....	9
6. GAME OPTION.....	11
8. MAINTENANCE & INSPECTION.....	14
9. OVERALL CONSTRUCTION.....	15
10. WIRING DIAGRAM.....	23

Thank you for purchasing **Octonauts-Peso GMP**. We hope you enjoy the product.

This manual contains valuable information about how to operate and maintain your game machine properly and safely. It is intended for the owner and/or personnel in charge of product operation. Carefully read and understand the instructions.

If you need any help during installation and setup please utilize this manual and troubleshooting guide. If the product fails to function properly, *non-technical personnel should under no circumstance attempt to service the machine*. Contact your distributor or manufacturer for help.

Before use, please read **IMPORTANT SAFETY INSTRUCTIONS**.

IMPORTANT SAFETY INSTRUCTIONS

To ensure the safe usage of this product, carefully read and understand these instructions before operating your game.

Save these instructions for future reference.

Use this product only as described in this manual. Other uses not recommended may cause fire, electric shock or personal injury. Unplug the game from the outlet when not in use, when moving from one location to another, and before cleaning/servicing.

Explanations which require special attention are indicated by signs of warning. Depending on the potential hazardous degree, the terms: **NOTE**, **NOTICE**, and **WARNING** are used.

NOTE: A NOTE indicates useful hints or information about product usage.

NOTICE: A NOTICE indicates potential damage to product and how to avoid the problem.

WARNING: A WARNING indicates a potential for product damage or serious personal injury.

It is important to understand the meaning of the following HAZARD SIGNS before continuing:

High Voltage and Shock Hazard:

High voltage can cause electric shock.
Turn off/unplug power before servicing.



High Temperature Hazard:

This part may cause scalding.
Do not touch. Surface may be hot.



No Touching Hazard:

This part may be hot or can cause electric shock.
Do not touch.



Use the following safety guidelines to help ensure your own personal safety and to help protect your equipment and surrounding environment from potential damage.

⚠️ This product is an indoor game machine. Do not install outdoors.

Avoid installing in the following places to prevent fire, electric shock, injury and/or machine malfunctioning:

- Places subject to rain/moisture, or places subject to high humidity.
- Places subject to direct sunlight, or places subject to extremely hot or cold temperatures to ensure that it is used within the specified operating range.
- Places where inflammable gas may be present or in the vicinity of highly inflammable/volatile chemicals or items that can easily catch fire.
- On unstable or sloped surfaces. The machine may topple or cause unforeseen accidents.
- Vicinity of fire exits, fire extinguishers etc that may block/prevent safety measures.

IMPORTANT NOTE:

ALL REPAIRS MUST BE DONE TO ORIGINAL MANUFACTURER SPECIFICATIONS. FAILURE TO DO SO VOID ALL WARRANTIES AND OPERATOR ASSUMES ALL RISKS.

Note: The contents of this manual may be updated without notice.

1. SPECIFICATIONS

Rated power supply: AC110V 50/60Hz; AC220V 50/60Hz

For 110V: Min. Power consumption: 250W

Max. Power consumption: 300W

For 220V: Min. Power consumption: 280W

Max. Power consumption: 450W

Dimension: W1063 ×D1450 ×H1200 mm

W41.85×D57.08×H47.24 in

Weight: Approximately 243.61 lb/110.5 KG

Part No: 0114

Model No: B-420



NOTICE: After turning off the game, please wait at least 1 minute before restarting again.

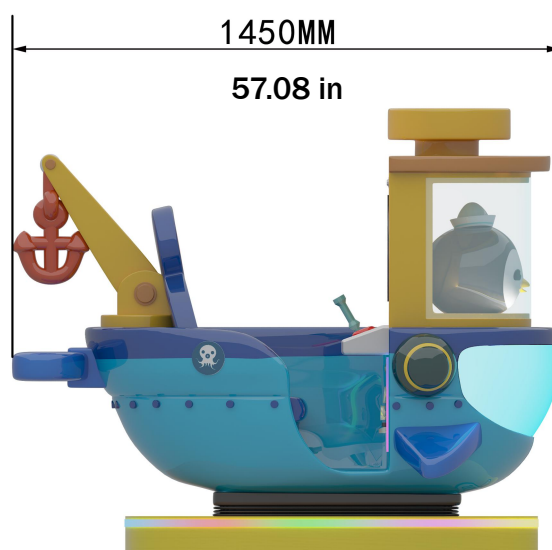
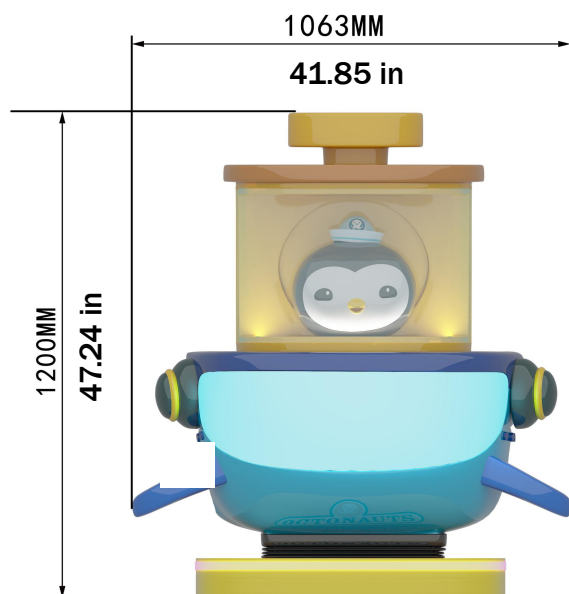







Note: Game specifications are subject to change without notice.

2. CONTENTS OF THE ACCESSORY KIT

Open the package and make sure all the items are included:

1. Following accessories

No.	Part No.	Name	Picture	Qty
1	0114-0148-00	2233 key		2
2	0114-0141-00	Power cord		1
3	0114-0120-00	Manual		1
4	0114-0146-00	2222 key		2
5	0114-0142-00	Fuse		2
6	0114-0163-00	DBV door plate		1

3. PART NAME

Key Components

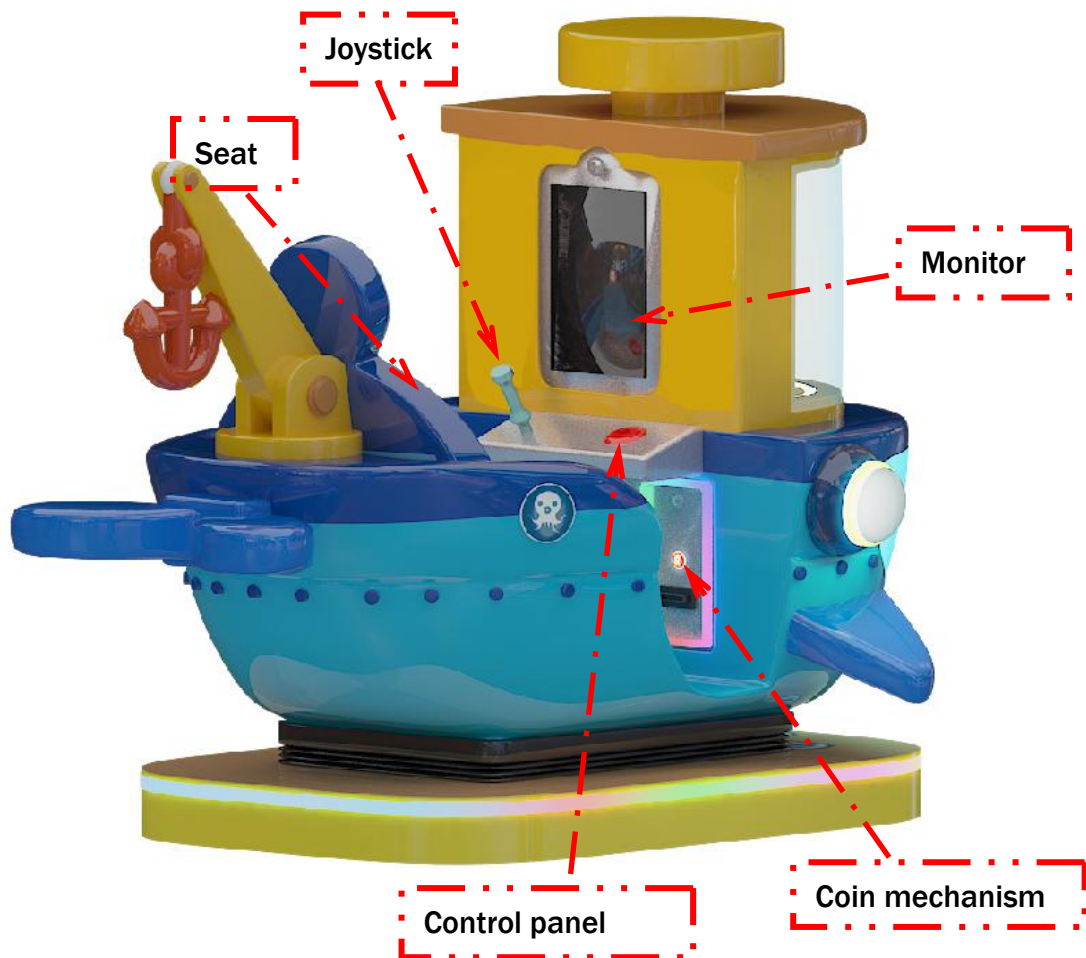

4. SET UP & INSTALLATION

⚠ NOTICE

We do not recommend using power tools as they may cause damage.

⚠ **This product is an indoor game machine. Do not install outdoors.**

- Refer to IMPORTANT SAFETY INSTRUCTIONS (Pg. 3) for places to avoid.
- Place the unit on a dry level surface.
- Ventilation openings in the back of the unit must not be obstructed by objects or by wall.

4.1 Transporting the Game

If you need to move the game, adjust the levelers back to an “up” position.

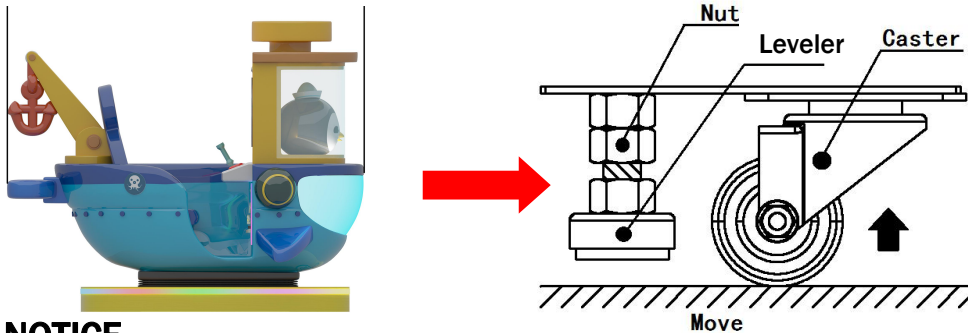

⚠ NOTICE

- Be careful not to damage the machine during transport.
- Always unplug the game before moving.
- Keep the machine in upright position during transport.
- For longer distance transport, package the game properly to prevent damages.

4.2 Level Adjustment

Install this game on a flat surface. If the game is installed on an unsuitable floor, it could cause game malfunction.

To secure the game, loosen the nut, utilize wrench to adjust the leveler down until it touches the floor, lifting the casters off the ground by 5mm/0.2 in. Repeat the same for all levelers.

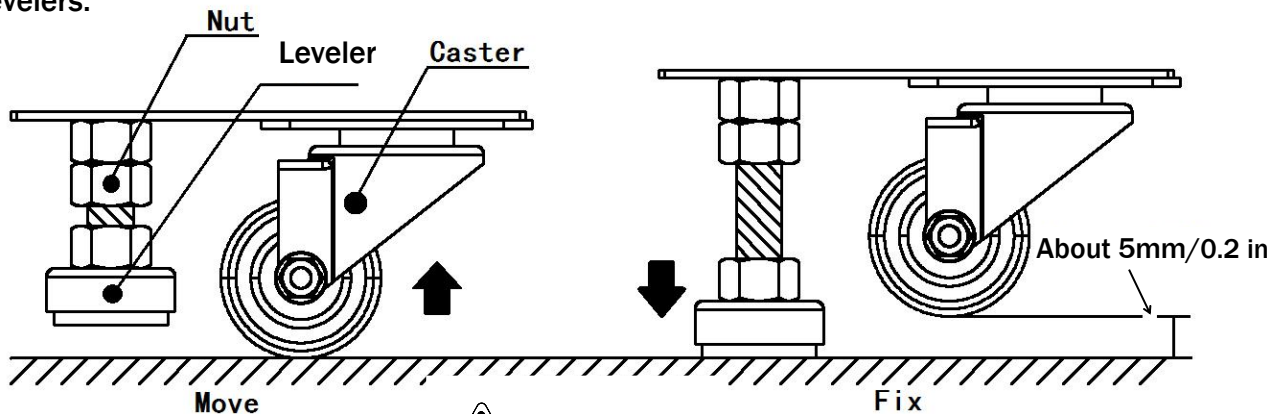

⚠ NOTICE

Make sure the machine is level.

4.3 Play Zone

This machine requires space for playing and for maintenance as shown below.

Leave space around the game upon installation:

Play area: 20 in

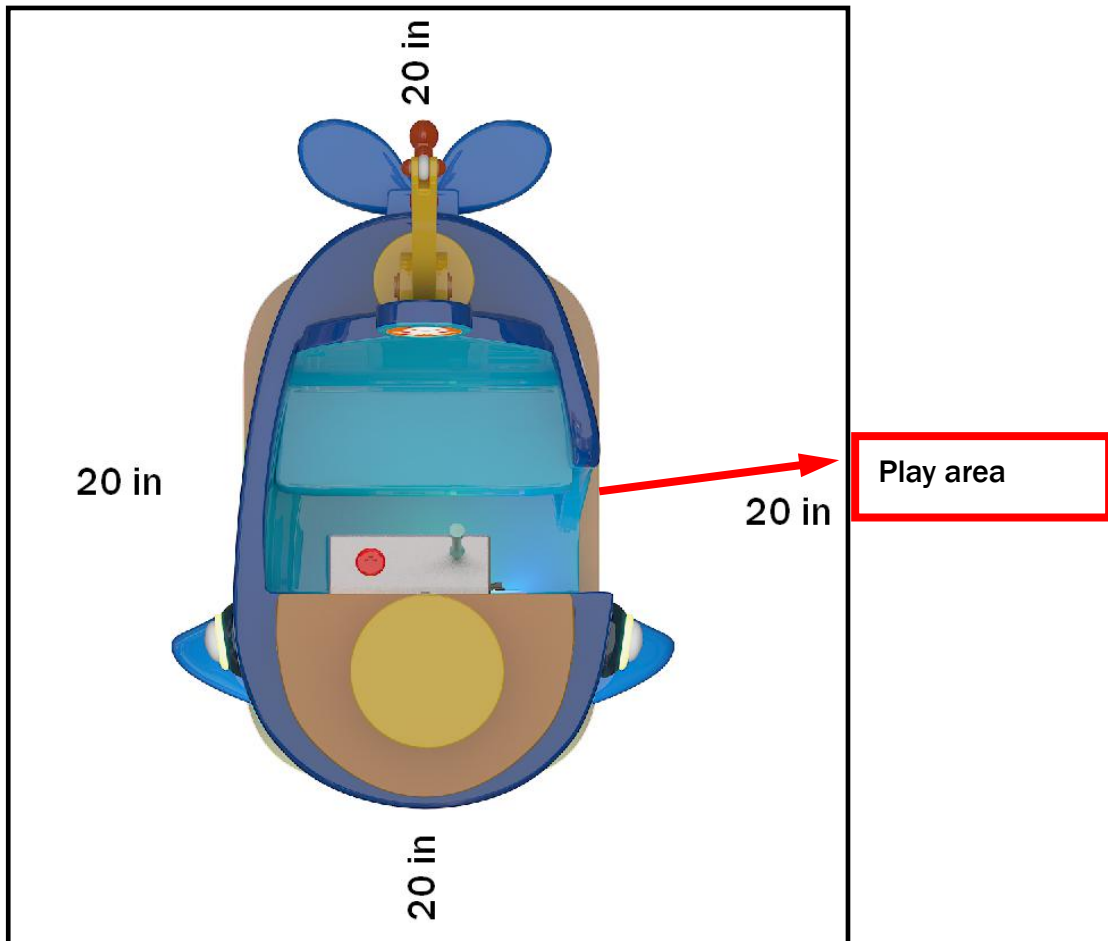

NOTICE

Your unit must be leveled to operate properly.

5. HOW TO PLAY

5.1 Insert coin to play.

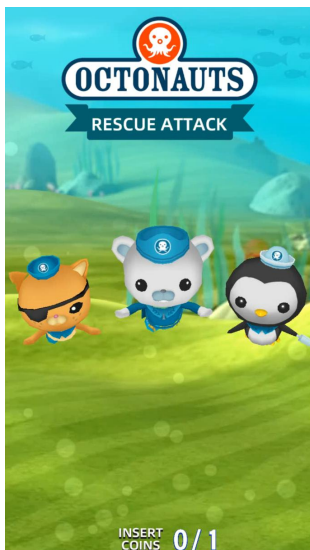

5.2 Tap button or control joystick to complete mission.

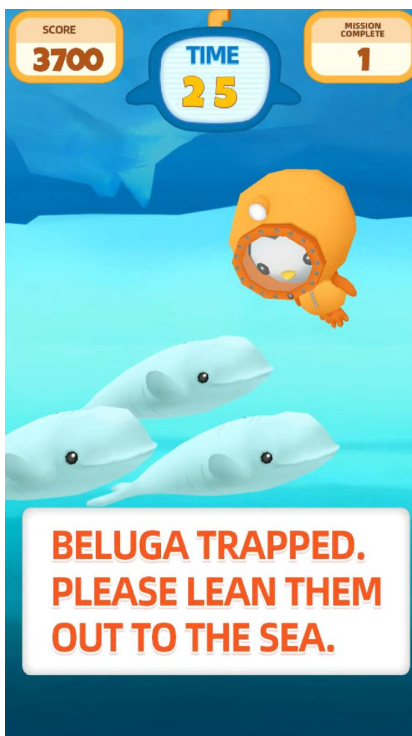
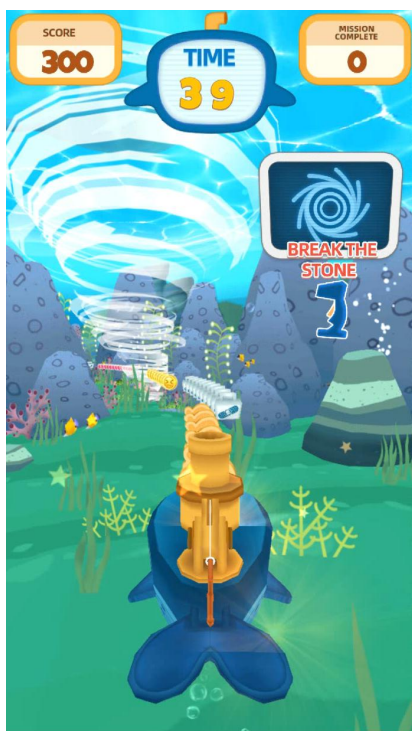

6. GAME OPTION

6.1 Adjustment button instruction

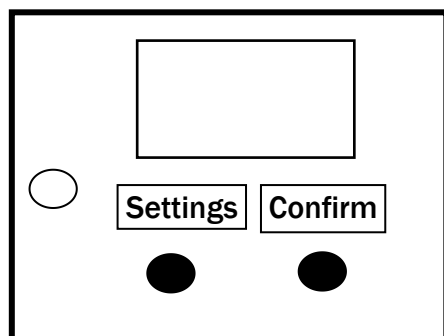

Open the coin door and there is a meter panel. Press Settings button to enter into the setting menu.

6.2 Setting menu

6.2.1 Main menu

Options
Basic Setting
Input Test
Output Test
Game Reset
Date/Time Setting
Language/语言
Bookkeeping
Daily Record
Back to game

6.2.2 Basic Setting

Options	Adjustable Value
Free Play	OFF/ON
Is Tickets Mode	Yes/No
Pay Mode	Inset Coins_Tap_Swipe Card
Attract Mode	OFF/ON
Memory Save	OFF/ON
Volume	0-10
Game Time	30-150
Coins Per Game(Fun play)	1-200
Coins Per Game 2(Card Out)	1-200
Go Back & Save	
Back	

6.2.3 Input Test

Options	Description
Coin	
Game Button	
Fire Button	

Options	Description
To Left	Joystick move left
To Right	Joystick move right
To Up	Joystick move up
To Down	Joystick move down

6.2.4 Output Test

Options
Light
Card Driver
Motor

6.2.5 Game Reset

Options
Factory restore
Reset Basic Setting
Clear all records
Clear unused coin

6.2.6 Date/Time Setting

Year	2010-2100
Month	1-12
Day	1-31
Hour(24)	0-23
Minute	0-59
Second	0-59
Go Back & Save	
Back	

6.2.7 Bookkeeping

Player1	Coins	Tickets/Cards	Payout
1	0	0	0.00

Back

6.2.8 Daily Record

Date	Weekday	RunTime	Coins	Tickets/Cards	Payout
2014-06-061	Fri	00:01	0	0	0.00

Prev. Page
Next Page
Clear
Back

7. TROUBLESHOOTING

7.1 Common Problem

Please confirm that all connectors fit tightly.

Symptom	Possible Cause	Recommended action
Game will not start	Frame assembly connector is loose.	Check connector.
	Frame assembly fault	Contact with UNIS Service.
Power off	Circuit protector make power SW in off state.	Turn on power SW again. If appeared again and again, machine has anomaly. Please contact with UNIS Service.
No sound	Low volume	Raise the volume.
	Connector loose.	Check connector.
	Speaker fault.	Check speaker.
	POT installation error.	Install POT correctly.
	POT fault.	Change POT.
	Audio cable problem.	Reconnect the audio cable or change it.
Display black screen	Driver problem	Restart the audio driver.
	Check connectors.	Plug in connector tightly
	Display fault.	Utilize another source such as a PC to verify if the display is operational.
	RAM is loose.	Remove and reinsert RAM.
	VGA signal cable is loose.	Check VGA cable
	"0X000000A" code appears. Conflict between computer drive and software.	Contact service

Note: After replacing component from pc (except for RAM), and replacing monitor, the game should be recovered again with the recovery stick attached to the machine.

If you see following error signs showing on the display, please try the recommended action.

Display	Possible Cause	Recommended action
	The connection part of the IO board is loose.	Check and reconnect the loose part of the IO board.
	IO board is faulty.	Reboot the game after checking connection and cable problem, if the problem remains unresolved, please call the service department for assistance.

8. MAINTENANCE & INSPECTION

8.1 Safety Check

Check the points listed before operating the machine. These checks are necessary for safe machine operation:

1. Test game before operation each day.
2. Conduct monthly routine checks of game components to ensure good working condition.
3. Check the machine regularly for dust and clean when necessary.

Note: Parts and components require preventative maintenance to maintain proper operation.

8.2 Handling Precautions

When installing or inspecting the machine, be very careful and pay attention to ensure that the player can enjoy the game safely.

Inappropriate handling running counter to the cautionary matters can cause personal injury or damage to the machine.

 **NOTICE**

We do not recommend using power tools as they may cause damage.

9. OVERALL CONSTRUCTION

9.1 General Assembly

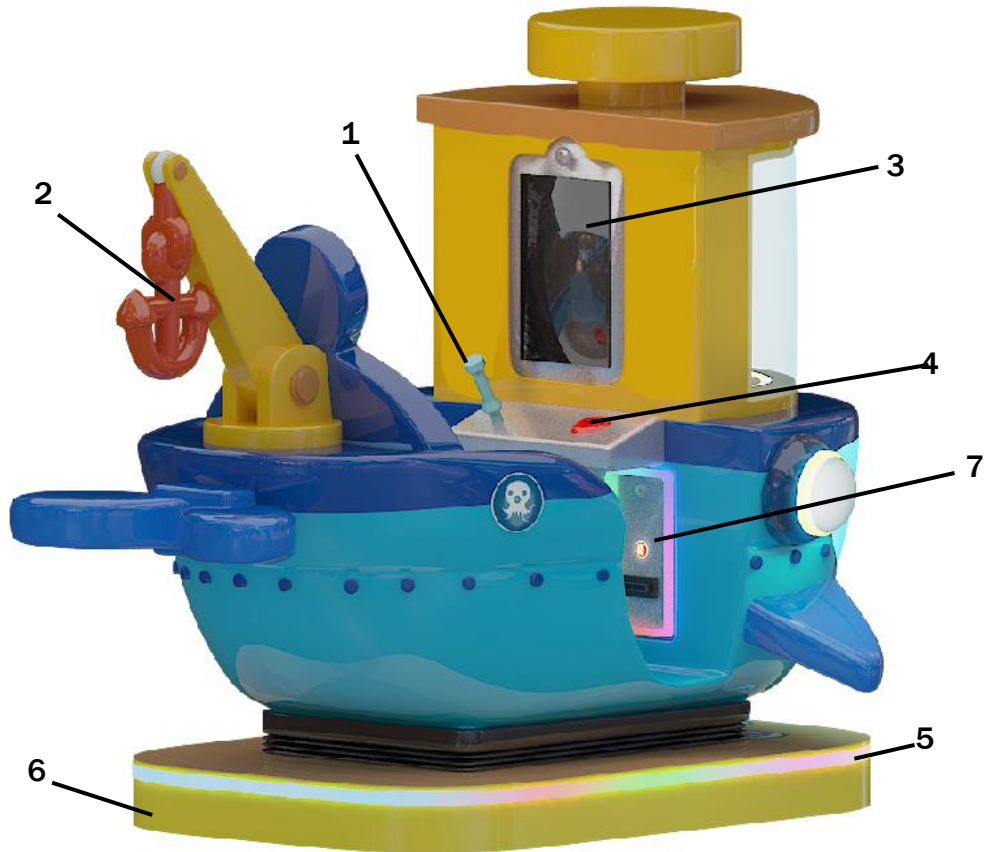

No.	Part No.	Name	Qty
1	0114-0122-00	Joystick	1
2	0114-0101-00	Cabinet shell	1
3	0114-0115-00	13.3" monitor acrylic	1
	0114-0123-00	13.3" monitor	1
	0114-0124-00	VGA cable	1
4	0114-0126-00	Button	1
	0114-0108-00	Button decal	1
5	0114-0103-00	Base assembly white plastic	1
6	0114-0151-00	Base assembly	1
7	0114-0152-00	Coin box plate&Service box	1

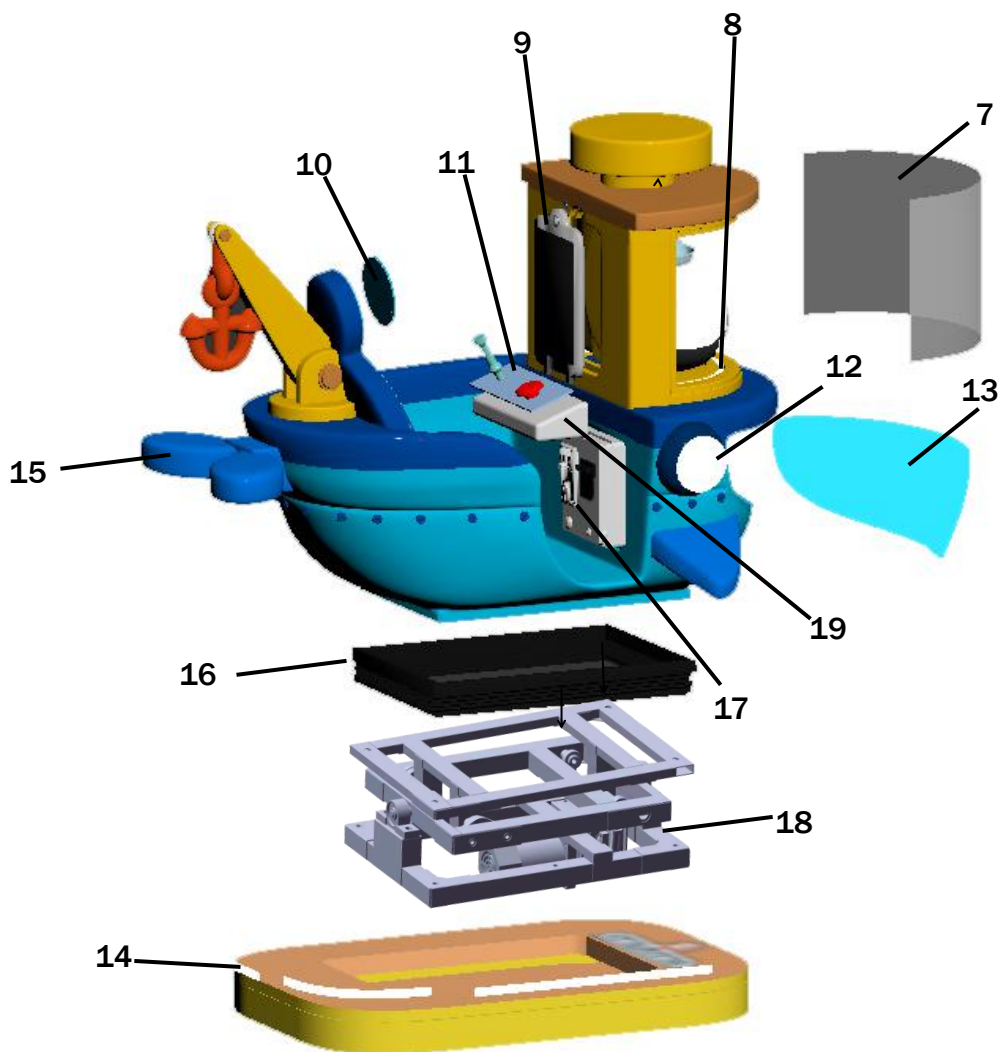

No.	Part No.	Name	Qty
7	0114-0112-00	Front clear acrylic	1
8	0114-0116-00	Half-round light tube	1
9	0114-0115-00	13.3" monitor acrylic	1
	0114-0154-00	Monitor plate	1
10	0114-0104-00	Fish tail acrylic	1
11	0114-0102-00	Control panel acrylic	1
12	0114-0114-00	Front eye plastic	2
13	0114-0113-00	Front blanking plate acrylic	1
14	0114-0103-00	Base assembly white plastic	1
15	0114-0101-00	Cabinet shell	1
16	0114-0149-00	Shaking bracket cover	1
17	0114-0128-00	Coin mechanism	1
18	0114-0150-00	Shaking bracket	1
19	0114-0153-00	Control panel plate	1

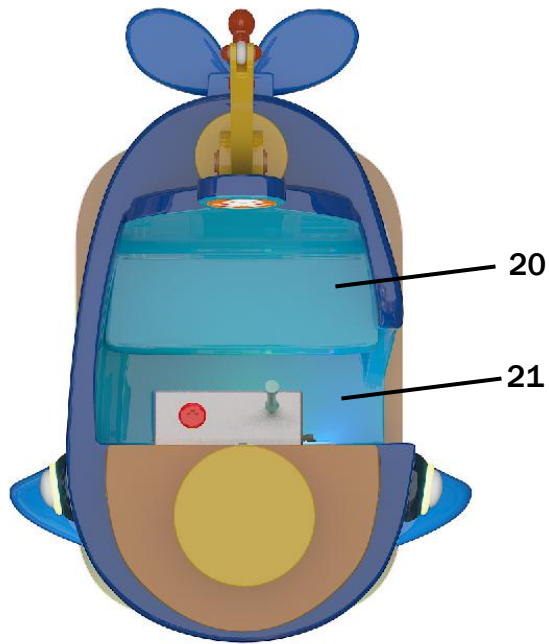

No.	Part No.	Name	Qty
20	0114-0118-00	Safety belt	1
	0114-0119-00	Seating cushion	1
21	0114-0117-00	Foot pad	1

9.2 Decal Part



1

2



3

4

5

No.	Part No.	Name	Qty
1	0114-0109-00	Octopus decal	1
2	0114-0105-00	Unis logo decal	1
3	0114-0107-00	Octopus decal(Red)	1
4	0114-0106-00	Octopus decal(Blue)	1
5	0114-0108-00	Button decal	1

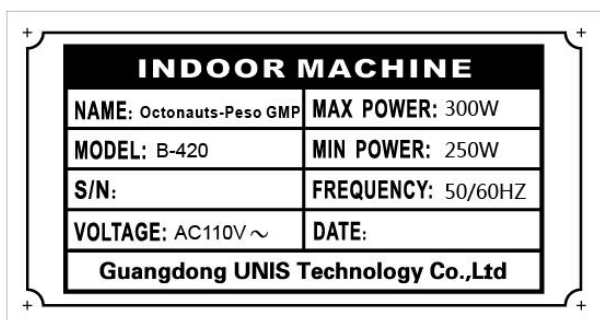

1

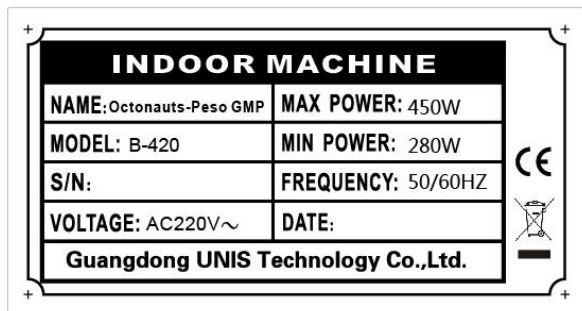

2

No.	Part No.	Name	Qty
1	0114-0161-00	110V nameplate	1
2	0114-0162-00	220V nameplate	1

1

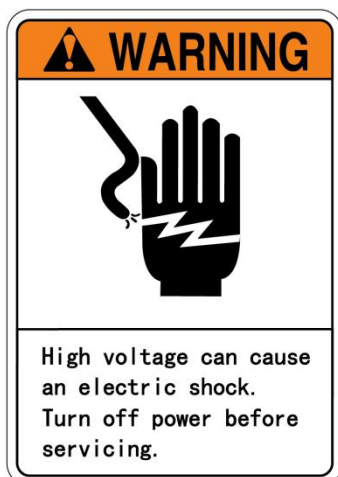

2



3



4



5

No.	Part No.	Name	Qty
1	0114-0156-00	High voltage label(L)	1
2	0114-0157-00	High voltage label	1
3	0114-0158-00	Maintenance label(Green)	1
4	0114-0159-00	Maintenance label(Yellow)	1
5	0114-0160-00	Maintenance label(Orange)	1

9.3 Electrical Part

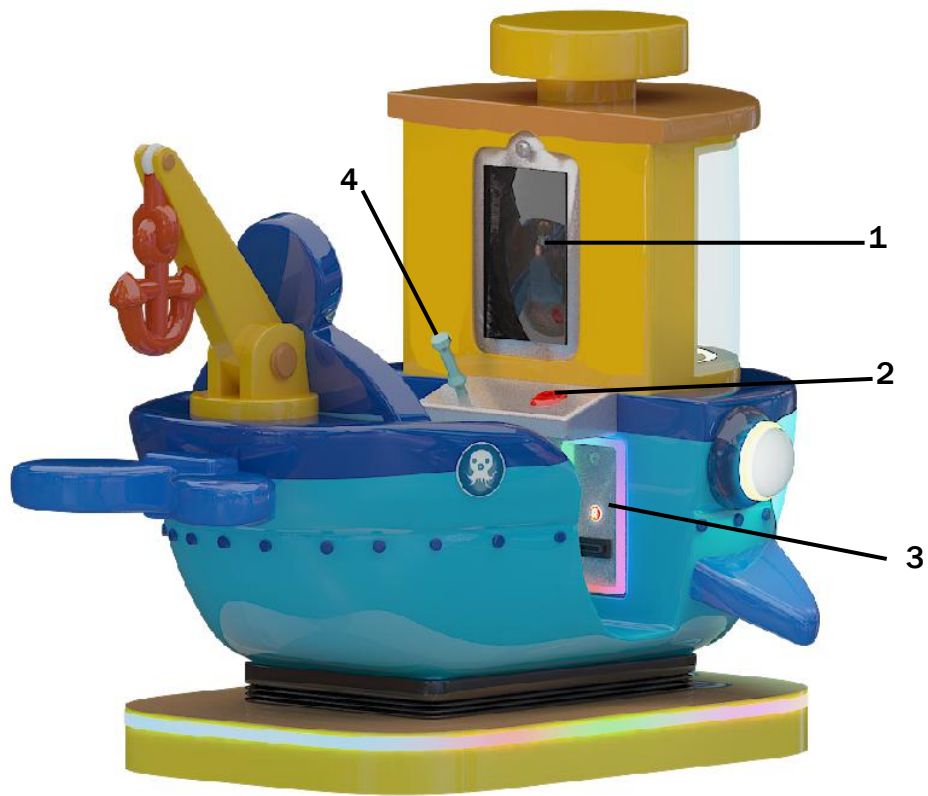

No.	Part No.	Name	Qty
1	0114-0123-00	13.3" monitor	1
	0114-0124-00	VGA cable	1
2	0114-0126-00	Button	1
3	0114-0128-00	Coin mechanism	1
4	0114-0122-00	Joystick	1



1



2



3



4



5



6



7



8



9

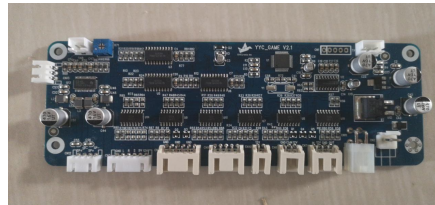

10



11



12



13



14



15



16

No.	Part No.	Name	Qty
1	0114-0121-00	Motor	1
2	0114-0127-00	4" speaker	1
3	0114-0129-00	Relay	1
4	0114-0135-00	Settings button	1
5	0114-0130-00	Power supply	1
6	0114-0132-00	Filter	1
7	0114-0133-00	Fuse board	1
8	0114-0134-00	Counter	1
9	0114-0136-00	Main board	1
10	0114-0137-00	IO board	1
11	0114-0142-00	Fuse	4
12	0114-0138-00	Eye white light strip	1.2
13	0114-0139-00	Yellow spotlight	1
14	0114-0140-00	RGB color light	3.9
15	0114-0143-00	IC controller	2
16	0114-0144-00	Light board	3

10. WIRING DIAGRAM

